



Mechanical Pressure Switches MDS

Monitoring the oil pressure is essential in hydraulic systems and oil supply systems. The measurement of maximum or minimum pressure has a direct effect on the safety of the system, the functionality or process reliability. It is important to monitor both process-related pressure ranges as well as safety shutdowns, load limits or simply to determine if the lubricating pressure is adequate.

MDS mechanical pressure switches serve system pressure monitoring. They are available with adjustable switch points.

robust and compact unit

adjustable switch point

high degree of accuracy

max. operating pressure up to 350 bars (others upon request)

electromechanical signal converter

M12 as well as M3 plug connector as per DIN EN 175301-803

changeover function

long service life



Technical Data MDS

MDS

Mediums	Self-lubricating fluids hydraulic fluid and lubricating oils, compressed air	
Process connection	G 1/8"	G 1/4"
Seal	Based on DIN3852-E	
Torque	20 Nm	25 Nm
Principle of Measurement	Membrane spring-loaded ≤ 16 bar	Piston spring-loaded ≥ 10 bar
max. working pressure	60 bar	350 bar
Materials	Membrane: NBR	Piston: Steel
Seal	---	PTFE, NBR
Housing	Steel, galvanised	Steel, galvanised
Switching output	Changeover contact	
Quantity	1	
Switching element	Microswitch with silver-plated contacts	
max. switching frequency	100/min	
Switching capacity using plug	M3	M12
DC up to 28 V	2 A	2 A
AC up to 250 V	4 A	---
Mounting position	Any	
Response	min. rate of pressure rise 0.01 bar/s	
Switching point / accuracy	± 2% from end value at room temperature	
Switching point / reproducibility	same as accuracy	
Ambient / operating temperature range	-20... +80°C	
Vibration resistance	A-10G / 10-500 Hz	
Shock resistance	I-100G/6 ms	

Switch-back difference

Membrane version

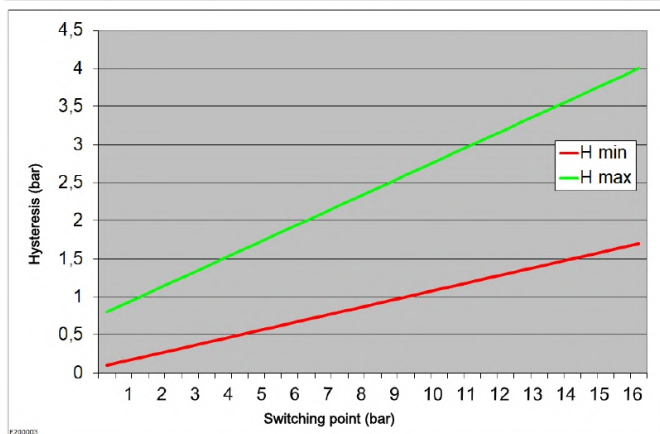

Piston version

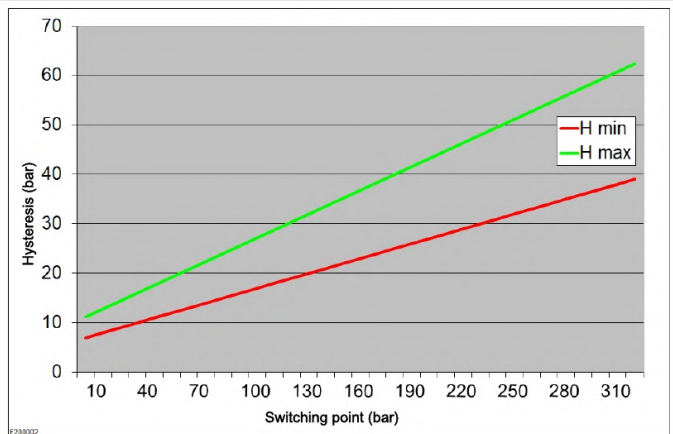

Plug connection

M3 (DIN EN 175301-803)

M12 (base)

Voltage

3-pin + PE

4-pin

IP rating

250 V

28 V

Cable fitting

IP65

IP67**

**when connected

Pin assignment

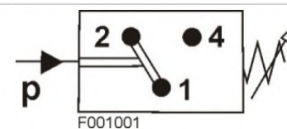
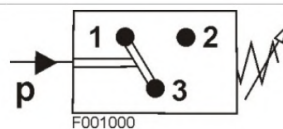

Dimensions MDS

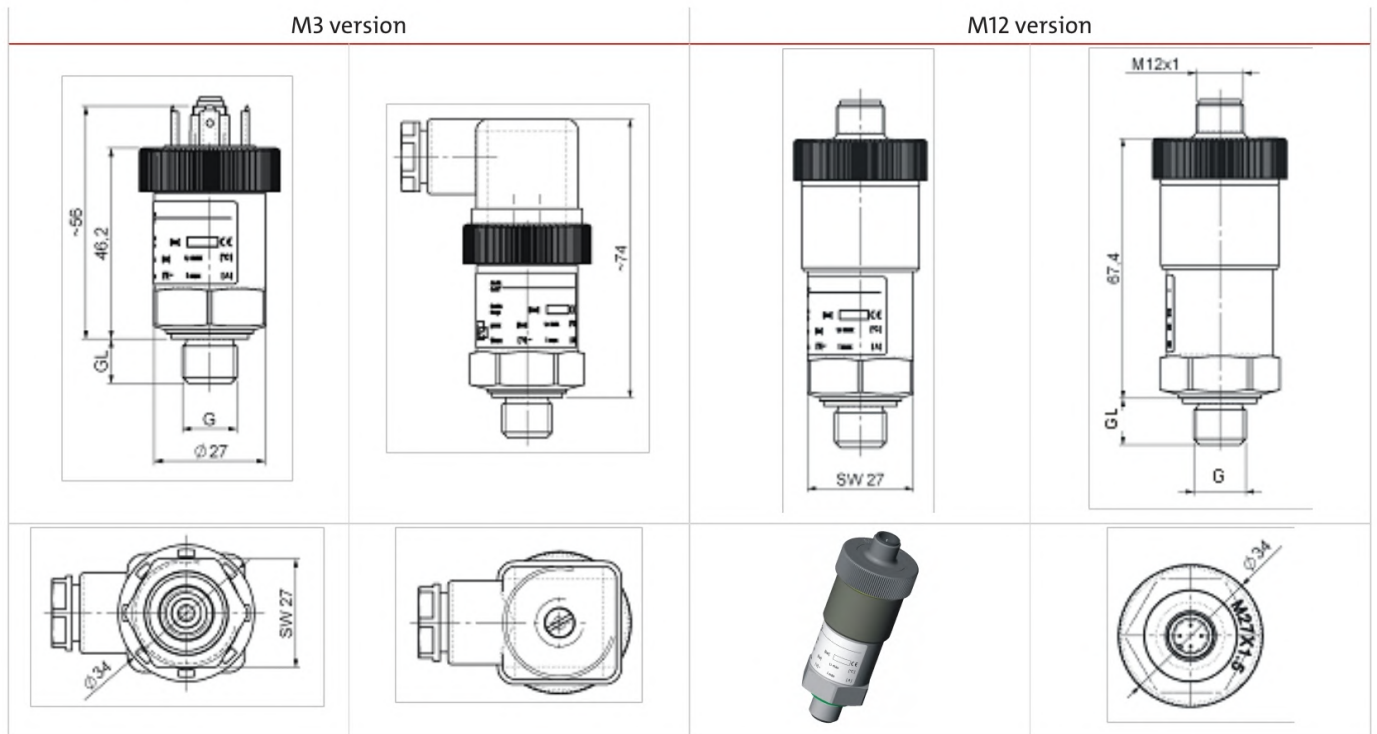

G	GL
1/8	10 mm
1/4	12 mm

Accessories:

Item no.: 9144050047	Connecting cable M12x1, 4-pin plug, L=5m
Item no. 9146100159	Electric line box M12x1, 90° angle

Model key MDS

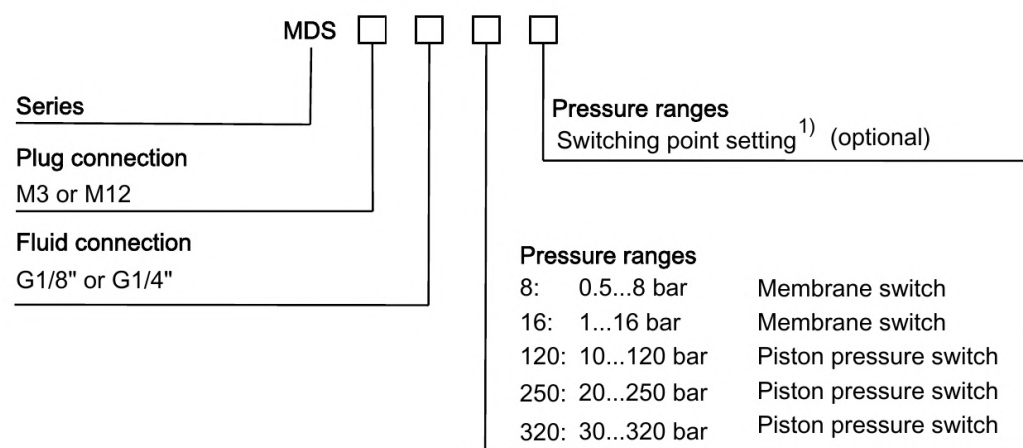

¹⁾ If necessary, the switching point can be set at the factory. The switching point must be selected with the pressure rising or falling, i.e. switching point from 0 bar to switching point (rising) or from the max. operating pressure to the switching point (falling). Please refer to the following example for the switching logic:

MDS-M3-G1/4-120-80R (switching point 80 bar rising):
Pin3-2 closed when switching point reached

MDS-M3-G1/4-120-80F (switching point 80 bar falling):
Pin3-1 closed when switching point reached

Technical Data MDSM and MDSK

	MDSM	MDSK
Mediums	Neutral fluids, compressed air	Self-lubricating fluids such as hydraulic fluids and lubricating oils
Process connection	G1/4" internal	G1/4" swivel, vertical flange, DIN ISO 16873, torque: 25 Nm
Mounting position	Any	Any
Principle of Measurement	Spring-loaded membrane	Spring-loaded piston
max. working pressure	60 bar	350 bar
min. rate of pressure rise	0.01 bar/s	0.01 bar/s
Switching point		
Accuracy/reproducibility	± 2% upper range value at room temp.	± 2% upper range value at room temp.
Materials		
Measuring element	Membrane: NBR	Piston: Stainless steel 1.4305
Pressure connection	Zinc diecasting (G1/4" internal)	Galvanised steel (G1/4" swivel), zinc diecasting (vertical flange)
Housing	Zinc diecasting	Zinc diecasting
Switching output	Changeover contact	Changeover contact
Quantity	1, adjustable with fastener	1, adjustable with fastener
Switching element	Microswitch with silver-plated contacts	Microswitch with silver-plated contacts
max. switching frequency	200 / min.	200 / min.
max. switching capacity		
with plug	M3 M12	M3 M12
DC up to 28V	3 A 3A	3 A 3A
AC up to 250V	6 A ---	6 A ---
Ambient conditions		
Ambient / operating temperature range	-10 °C...+80 °C	-10 °C...+80 °C
Vibration resistance	A-10G/10-500 Hz	A-10G/10-500 Hz
Shock resistance	I-100G/6 ms	I-100G/6 ms
Weight	0.3 kg	0.33 kg

Switch-back difference:

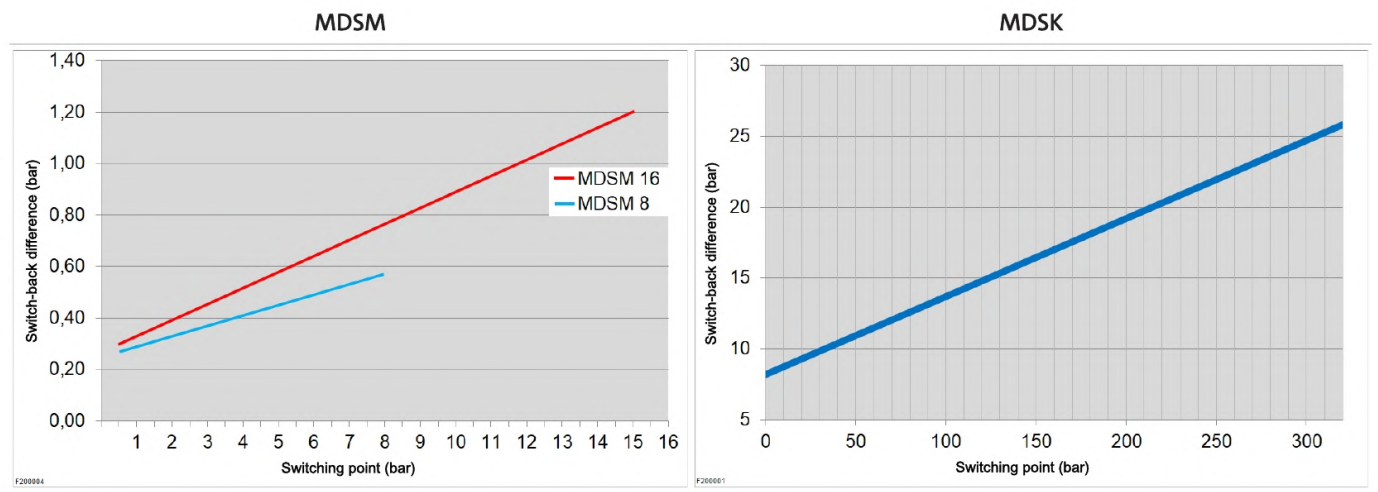

Plug connection

Max. voltage
IP rating
Cable fitting

M3 (DIN EN 175301-803)
3-pin + PE
250 V
IP65
PG9

M12 (base)
4-pin
28 V
IP67**

**when connected

Pin assignment

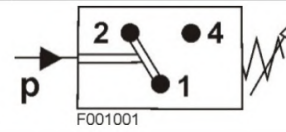
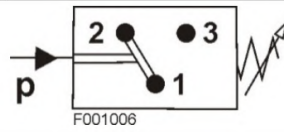

Dimensions MDSM and MDSK

Dimensions MDSM

M3 version			M12 version	
Electric line box included		Rigid internal thread	Rigid internal thread	

Dimensions MDSK

M3 version with thread		M3 version with vertical flange DIN ISO 16873	
Electric line box included		External thread swivel	

G 1/4 GL 92 mm

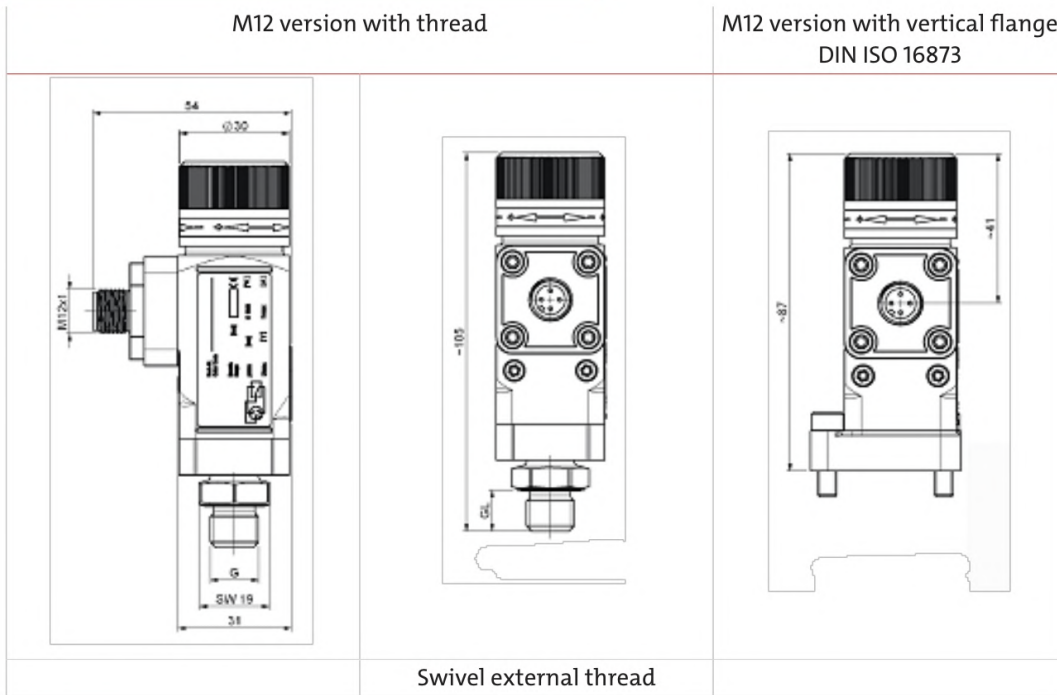

Accessories:

Item no.: 9144050047	Connecting cable M12x1, 4-pin plug, L=5m
Item no.: 9146100159	Electric line box M12x1, 90° angle
Item no.: 9008429	Double nipple G1/4, stainless steel

Model key MDSM and MDSK

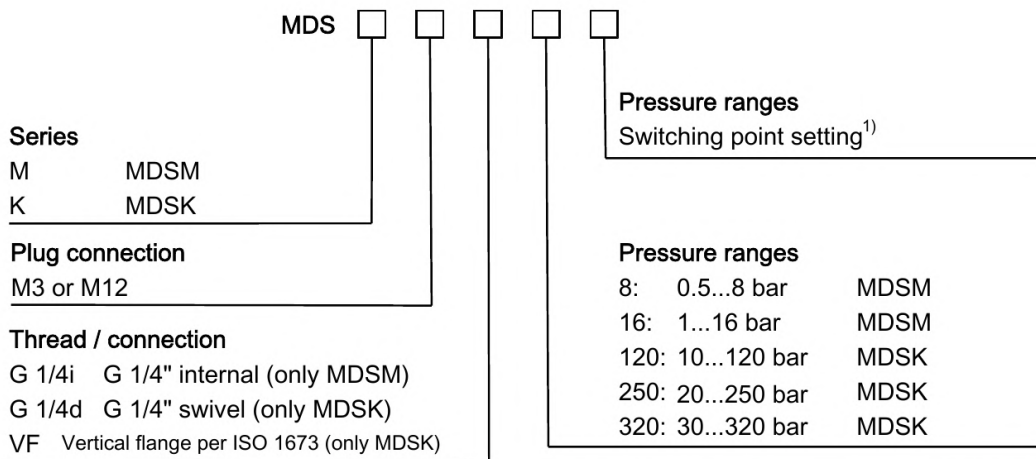

¹⁾ If necessary, the switching point can be set at the factory. The switching point must be selected with the pressure rising or falling, i.e. switching point from 0 bar to switching point (rising) or from the max. operating pressure to the switching point (falling). Please refer to the following example for the switching logic:

MDSK-M3-G1/4-120-80R (switching point 80 bar rising)
PIN1-3 closed when switching point reached

MDSK-M3-G1/4-120-80F (switching point 80 bar falling)
PIN1-2 closed when switching point reached